



Proven Performance™

K-Bar Industries, Faribault, MN 55021

MA1578111D

<p>ITEM NUMBERS: A1573701, A1573981, A1577541, A1578111, A1578171, A1578131, A1578181, A1578151, A1578201</p>

Owner's Manual

Pressure Washer Pump: For high pressure cleaning machines.

	⚠ WARNING
	<p>Read this manual. Serious injury or death can result if safety instructions are not followed.</p>

	<p>Pump is shipped with oil.</p> <ul style="list-style-type: none"> - Remove shipping plug and install vented fill cap. (Comet Pumps) - Remove shipping tape from pump oil fill cap. (Cat Pumps) - Remove shipping plug and install dipstick. (General Pumps) - See pump oil cap section of this manual.
	<p>Closely inspect all components.</p> <ul style="list-style-type: none"> -If you have damaged components then: Contact the freight company that delivered the unit and file a claim. -If you have missing components then: Contact Customer Service at 1-800-270-0810.

fig01914

Any Questions, Comments, Problems or Parts Orders

Call NorthStar Customer Service 1-800-270-0810

Hazard Signal Word Definitions





	<p>This is the safety alert symbol. It is used to alert you to potential personal injury hazards. Obey all safety messages that follow this symbol to avoid possible injury or death.</p>
	<p>DANGER (red) indicates an imminently hazardous situation which, if not avoided, will result in death or serious injury.</p>
	<p>WARNING (orange) indicates a potentially hazardous situation which, if not avoided, could result in death or serious injury.</p>
	<p>CAUTION (yellow) indicates a potentially hazardous situation which, if not avoided, may result in minor or moderate injury.</p>
	<p>CAUTION (yellow) used without the safety alert symbol indicates a potentially hazardous situation which, if not avoided, may result in property damage.</p>

fig01453

Table of Contents

▲ Important Safety Rules	4,5
Pump Oil Cap and Pump Component Identification...	6
▲ Operation Instructions	7-9
Water Supply.....	7
Start-Up/Shut-Down Instructions.....	8
Applying Chemicals.....	9
▲ Maintenance and Storage.....	10-12
Maintenance Mode and Maintenance Schedule...	10
Pump Oil Change.....	11
Long Term Storage.....	12
Winter Storage.....	12
Troubleshooting	13
Specifications	14
Parts Explosions	15

⚠ Important Safety Rules





⚠ WARNING	
	<p>1.) Read owner's manual completely. Serious injury or death can result if safety instructions are not followed. You must be 16 or older to operate this machine. Keep untrained people away.</p>
	<p>2.) Skin puncture hazard. High pressure fluid can inject under skin resulting in serious injury including amputation. Do not direct spray at people or animals. -If skin injection happens, seek IMMEDIATE surgical treatment. -Do not check for leaks with hand. Instead, use a piece of cardboard to check for leaks. -Do not use unit if exterior hose damage is evident. Make sure all fittings are tight before starting. Relieve system pressure before servicing. -Know how to stop engine and bleed pressures quickly. Be thoroughly familiar with the controls. -Make sure accessories meet the unit's temperature and pressure limits. -Stop engine, bleed pressure, and engage spray gun safety lock before leaving unit unattended.</p>
 	<p>3.) Risk of fire and explosion. Hot exhaust fumes from engine can cause fire. Gasoline is highly flammable and explosive. You can be burned or seriously injured when handling fuel. -Position muffler at least 7 feet from combustible objects. -Before adding fuel, stop the engine and keep heat, sparks, and flame away. Do not add fuel when engine is running or still hot. No smoking near engine. -Do not pump fuel directly into engine at gas station. Static charge can build and ignite fuel. Use a UL approved fuel container to transfer gas to the engine. Wipe up fuel spills immediately. -Only store and handle fuel outdoors. Gasoline vapors can ignite if they collect inside an enclosure. Explosion can result. -Do not change or add to exhaust system. Fire can result. -Do not change or add fuel tanks or fuel lines. Fire can result. -Before each use, check fuel tank and fuel lines for leaks. Any fuel leak is a fire hazard. Fix any fuel leaks before starting engine. -During transportation take precautions to make sure pressure washer will not tip over and cause a fuel leak fire hazard.</p>
	<p>4.) Poisonous gas. This machine gives off carbon monoxide, a poisonous gas that can kill you. You CANNOT smell it, see it, or taste it. -ONLY run machine outdoors and away from air intakes. -NEVER run machine inside homes, garages, sheds, or other semi-enclosed spaces. These spaces can trap poisonous gases, EVEN IF you run a fan or open doors and windows. If you start to feel sick, dizzy, or weak while using this machine, shut it off and get to fresh air RIGHT AWAY. See a doctor. You may have carbon monoxide poisoning.</p>

fig01572

Save These Instructions

⚠ Important Safety Rules

⚠ WARNING



5.) Risk of exposure to dangerous chemicals.

Serious injury or death can result if chemical manufacturer instructions are not followed.

- Wear protective gloves when handling and cleaning with chemicals.
- Understand all safety hazards and first aid for all chemicals being used.
- When cleaning filters, check if chemicals have been used and take any precautions that are recommended by the chemical manufacturer.
- Different chemicals may interact dangerously with each other, always follow chemical manufacturer directions before switching chemicals.
- Calculate the correct amount of chemical to mix, dispose of excess chemical per the manufacturer instructions.
- Never spray flammable liquids.



6.) Risk of electrocution.

Electricity can kill you. Keep water away from electrical outlets and electrical devices.

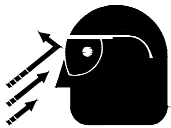

7.) Flying objects.

Small particles may fly out while spraying. Wear safety glasses. Serious eye injury can occur. Make sure nozzle is secure before squeezing trigger. If nozzle is not secure it will become a projectile.



8.) Fall hazard.

Pressure washer creates puddles and slippery surfaces. Keep good footing and balance. Serious injury can occur.

- Wear footwear capable of maintaining a good grip on wet surfaces.
- Gun kicks back. Hold with both hands.
- Do not overreach or stand on unstable supports.
- Do not stand on ladders or scaffolding.
- Do not place pressure washer on soft or unstable ground.



⚠ CAUTION

1.) Hot muffler.

You can be burned by muffler. Do not touch.

fig01846

Save These Instructions

Pump Oil Cap and Pump Component Identification

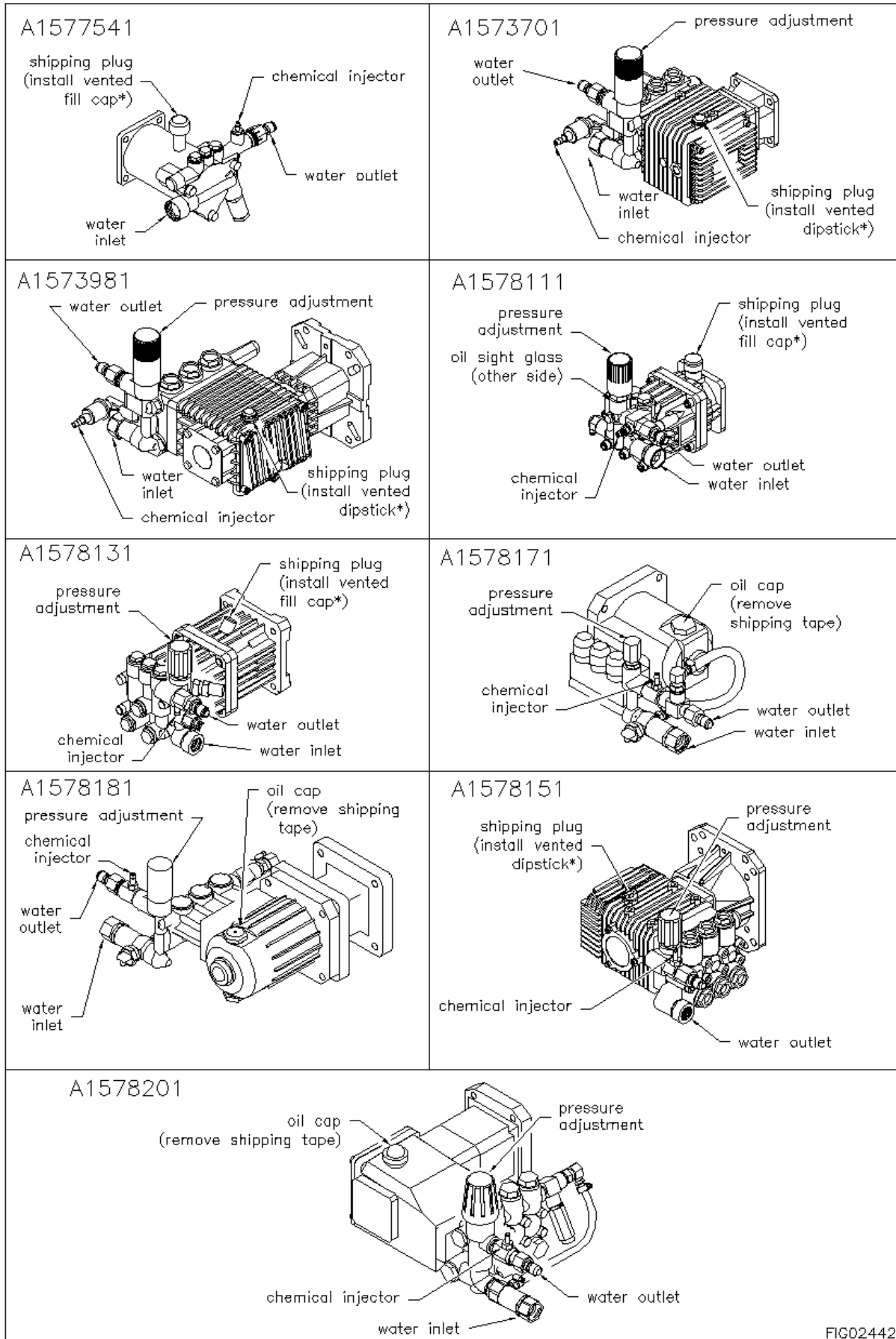

FIG02442

*Note: Discard shipping plug and o-ring.

⚠ Operation Instructions

Water Supply

- 1.) Make sure the water supply is clean. Debris can cause excess pump wear and reduce performance.
- 2.) An insufficient water supply will damage your pump. Make sure the water supply is steady and is 20% over the rated flow of your pump. Use a stopwatch to time how long it takes to fill a 5 gallon bucket with your garden hose. The bucket must fill faster than the times listed in the table below.

Model	Time to fill 5 gallon bucket
A1577541	100 seconds
A1573981	84 seconds
A1573981	58 seconds
A1578111	100 seconds
A1578131	84 seconds
A1578151	72 seconds
A1578171	100 seconds
A1578181	84 seconds
A1578201	72 seconds

- 3.) The water supply garden hose must have an inside diameter of at least 5/8". If the hose is more than 100 ft. long, the diameter must be at least 3/4".
- 4.) Never use a reservoir tank as a water source. Drawing water out of a tank may cause pump cavitation and damage to your pump. This pressure washer is designed for a pressurized water source such as a city water faucet. However, the water source pressure must not exceed 115 psi (8 bar).
- 5.) Always use a flexible rubber hose for your water supply. Do not use rigid piping.

⚠ Operation Instructions

Start-Up Instructions

1. Attach garden hose to water inlet.
2. Attach pressure hose to water outlet and gun.
3. Attach spray gun to lance.
4. Turn water supply ON.
5. Squeeze trigger to purge air from pump.
6. Insert nozzle.
7. Start engine.

Shut-Down Instructions

1. Turn engine OFF.
2. Turn water supply OFF.
3. Squeeze trigger to relieve system pressure.
4. Remove garden hose.
5. Remove pressure hose.
6. Turn fuel valve OFF (if equipped).

	<p style="text-align: center;">⚠ WARNING</p> <p>Skin puncture hazard. High pressure fluid can inject under skin resulting in serious injury including amputation. Do not direct spray at people or animals. -If skin injection happens, seek IMMEDIATE surgical treatment. -Do not check for leaks with hand. Instead, use a piece of cardboard to check for leaks. -Do not use unit if exterior hose damage is evident. Make sure all fittings are tight before starting. Relieve system pressure before servicing. -Know how to stop engine and bleed pressures quickly. Be thoroughly familiar with the controls. -Make sure accessories meet the unit's temperature and pressure limits. -Stop engine and bleed pressures before leaving unit unattended.</p>
---	---

fig01863

⚠ Operation Instructions

Applying Chemicals

- 1.) Install the black nozzle to spray chemicals onto the cleaning surface.
- 2.) Start the pressure washer according to the start-up instructions.
- 3.) Submerge the chemical hose in cleaning solution.
- 4.) Squeeze the spray gun trigger. The chemical injector will draw the chemical into the water stream.
- 5.) Apply chemicals evenly onto the cleaning surface. Allow the chemicals to react with the dirt, then clean at high pressure with green nozzle.
- 6.) Never use more chemical than is necessary to clean the surface.
- 7.) To clean the chemical injector, draw water through the strainer until all the chemical is purged from the system.

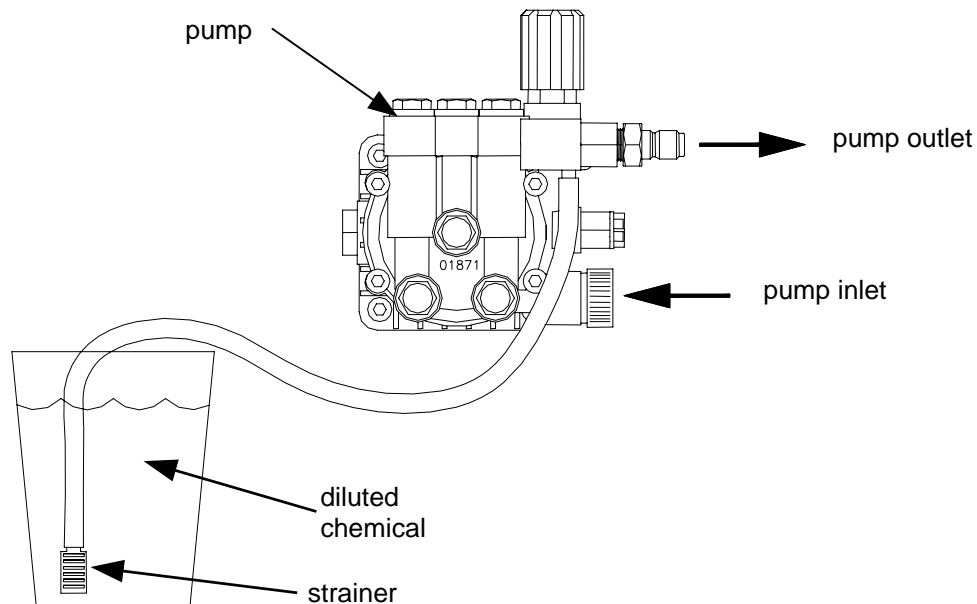

⚠ WARNING

Risk of exposure to dangerous chemicals.

Serious injury or death can result if chemical manufacturer instructions are not followed.

- Wear protective gloves when handling and cleaning with chemicals.
- Understand all safety hazards and first aid for all chemicals being used.
- When cleaning filters, check if chemicals have been used and take any precautions that are recommended by the chemical manufacturer.
- Different chemicals may interact dangerously with each other, always follow chemical manufacturer directions before switching chemicals.
- Calculate the correct amount of chemical to mix, dispose of excess chemical per the manufacturer instructions.
- Never spray flammable liquids.



fig01846

⚠ Maintenance and Storage

Maintenance Mode

Before performing any maintenance on the pressure washer, it must be placed in maintenance mode.

- 1.) Turn off engine.
- 2.) Turn off water supply.
- 3.) Squeeze trigger to relieve system pressure.
- 4.) Shut off fuel valve.
- 5.) Unplug spark plug wire from spark plug, (see engine owners' manual).

Maintenance Schedule

What to Check	When To Check	What to Do
Inlet Filter	Each Use	Visually inspect and clean inlet filter with clear water.
Pressure Hose	Each Use	Visually inspect pressure hose and hose couplings. Replace hose if any of the following is evident: hose coupling is damaged, wire mesh is exposed or damaged, hose is permanently kinked or flattened, outer hose cover is blistered or loose.
Bolts	Each Use	Tighten any loose bolts.
Engine Oil	See engine manual	See engine manual for oil change instructions
Pump Oil	After 1 st 50hrs, then 3mo/500hr	Change pump oil. See pump oil change instructions on next page.

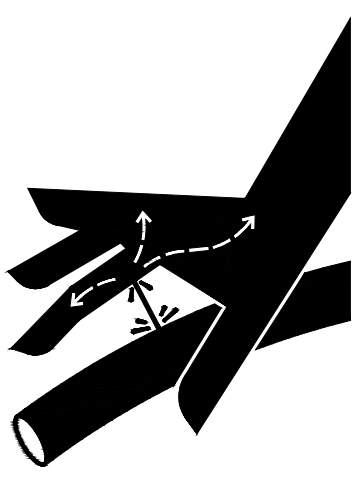

⚠ WARNING

Skin injection hazard.

High pressure fluid can inject under skin resulting in serious injury including amputation.

- Make sure all fittings are tight before applying pressure. Relieve system pressure before servicing.
- Do not check for leaks with hand. Instead, use a piece of cardboard to check for leaks.
- If skin injection happens, seek immediate "Surgical Treatment".

fig01454

▲ Maintenance and Storage

Pump Oil Change

- 1.) Place a suitable container below the pump to catch the used oil, then remove the oil fill cap and oil drain plug.
- 2.) Allow the used oil to drain completely, then reinstall the drain plug and tighten securely.
- 3.) Please dispose of used oil in a manner that is compatible with the environment. We suggest you take used oil in a sealed container to your local recycling center or service station for reclamation. Do not throw it in the trash, pour it on the ground or down the drain.
- 4.) With the pump in a level position, fill to the half way point on the oil sight glass (see pump oil capacities below). For Comet pumps use Universal Tractor Transmission Oil or Mobil1 synthetic oil (15W50). For Cat pumps use SAE30 non-detergent oil or Cat Pump Oil Item# 22158.

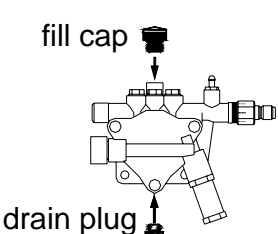
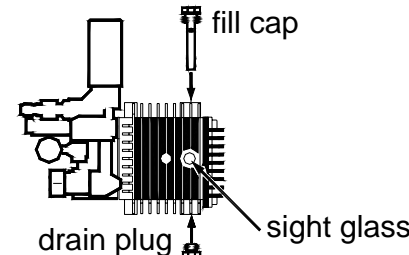
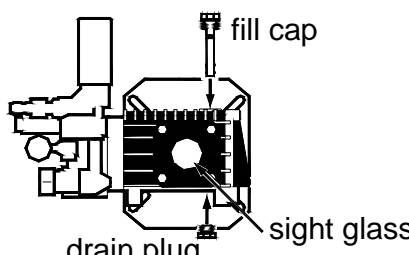
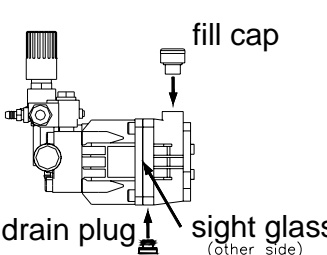
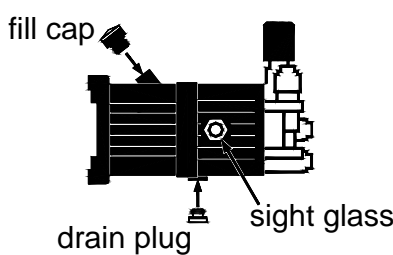
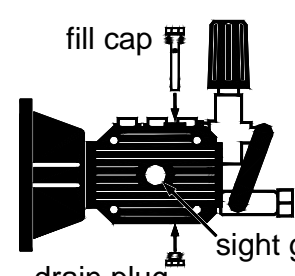
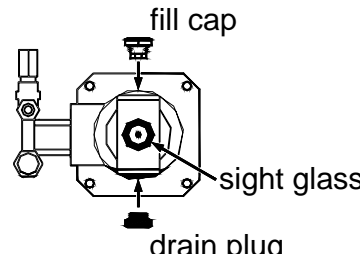
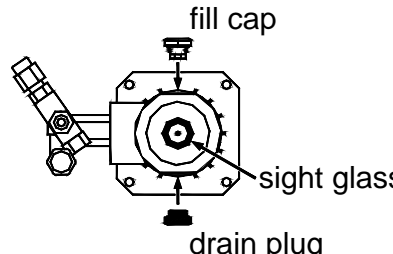
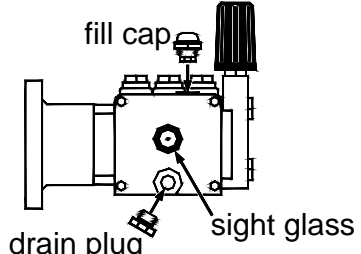
<p>A1577541</p>  <p>fill cap</p> <p>drain plug</p> <p>Oil capacity: 3.4 oz. (.10 L)</p>	<p>A1573701</p>  <p>fill cap</p> <p>drain plug</p> <p>sight glass</p> <p>Oil capacity: 11 oz. (.33 L)</p>	<p>A1573981</p>  <p>fill cap</p> <p>drain plug</p> <p>sight glass</p> <p>Oil capacity: 14 oz. (.41 L)</p>
<p>A1578111</p>  <p>fill cap</p> <p>drain plug</p> <p>sight glass <small>(other side)</small></p> <p>Oil capacity: 4.3 oz. (.13L)</p>	<p>A1578131</p>  <p>fill cap</p> <p>drain plug</p> <p>sight glass</p> <p>Oil capacity: 5.7 oz. (.17L)</p>	<p>A1578151</p>  <p>fill cap</p> <p>drain plug</p> <p>sight glass</p> <p>Oil capacity: 10.3 oz. (.30L)</p>
<p>A1578171</p>  <p>fill cap</p> <p>drain plug</p> <p>sight glass</p> <p>Oil capacity: 8.5 oz. (.25L)</p>	<p>A1578181</p>  <p>fill cap</p> <p>drain plug</p> <p>sight glass</p> <p>Oil capacity: 10.2 oz. (.30L)</p>	<p>A1578201</p>  <p>fill cap</p> <p>drain plug</p> <p>sight glass</p> <p>Oil capacity: 22.6 oz. (.62L)</p>

02444

▲ Maintenance and Storage

Long Term Storage

Follow the engine owner's manual for storing the engine.

Winter Storage

Protect your pump, hose, and gun from freezing.

Items needed: 12" piece of garden hose or equivalent, funnel and RV antifreeze (approximately 6 oz.)

- 1.) Follow the storage instructions listed above.
- 2.) Disconnect spark plug cable. Make sure the engine start switch is OFF, and the fuel valve is OFF.
- 3.) Attach the garden hose with funnel to the pump inlet (see illustration).
- 4.) Pour RV antifreeze into the funnel, pull the engine recoil until antifreeze comes out the pump outlet.
- 5.) Drain all water from the high pressure hose. Depress trigger on gun and drain all water out of gun/lance.

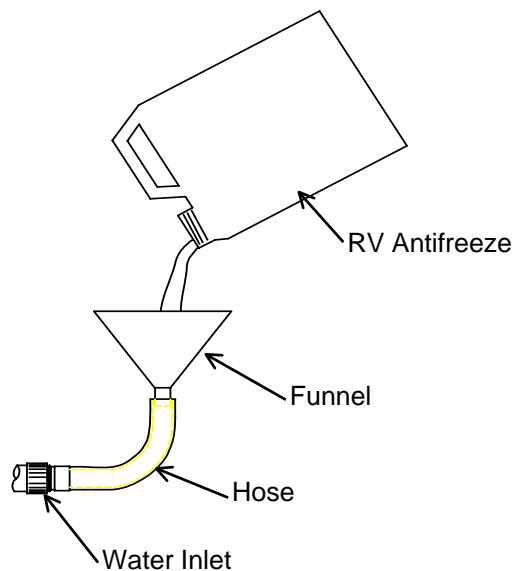

Troubleshooting

Problem	
Engine will not start	SOLUTION: A,B
Low/Surging pressure or no water flow	SOLUTION: C,D,E,F,G,H
No chemical injection	SOLUTION: I,J,K,L
Cause	Solution
A- Low oil shutdown	See engine manual for oil requirements
B- Engine starting instructions not followed	See engine manual for starting instructions
C- Insufficient water supply	See water supply section of this manual
D- Plugged pump inlet filter	See maintenance section of this manual
E- Wrong nozzle	Make sure high pressure nozzle is being used
F- Plugged nozzle	Remove nozzle, check for blockage
G- Worn nozzle	Replace nozzle
H- Leak in pressure hose	Replace pressure hose
I- Wrong nozzle	Make sure chemical nozzle is being used
J- Back pressure from extra long discharge hose	Try shorter hose
K- Leak in chemical siphon hose	Replace hose – use hose clamps if necessary
L- Chemical strainer not submerged	Make sure strainer is completely submerged

Any Questions, Comments, Problems or Parts Orders

Call Northstar Customer Service 1-800-270-0810

Specifications

A1577541

PSI	2700
GPM	2.5
Max Water Temp	140°F
Power	5-6.5hp Gas engine
Shaft size	¾" keyed
Nozzle size	#3.0

A1573981

PSI	3000
GPM	4.0
Max Water Temp	140°F
Power	11-13 hp Gas engine
Shaft size	1" keyed
Nozzle size	#4.5

A1578171

PSI	2750
GPM	2.5
Max Water Temp	140°F
Power	5-6.5hp Gas engine
Shaft size	¾" keyed
Nozzle size	#3.0

A1578181

PSI	3200
GPM	3.0
Max Water Temp	140°F
Power	8-9hp Gas engine
Shaft size	1" keyed
Nozzle size	#3.5

A1578201

PSI	4000
GPM	3.5
Max Water Temp	140°F
Power	11-13hp Gas engine
Shaft size	1" keyed
Nozzle size	#3.5

A1573701

PSI	2000
GPM	3.0
Max Water Temp	140°F
Power	5-6.5 hp Gas engine
Shaft size	¾" keyed
Nozzle size	#4.0

A1578111

PSI	2700
GPM	2.5
Max Water Temp	140°F
Power	5-6.5hp Gas engine
Shaft size	¾" keyed
Nozzle size	#3.0

A1578131

PSI	3000
GPM	3.0
Max Water Temp	140°F
Power	8-9hp Gas engine
Shaft size	1" keyed
Nozzle size	#3.5

A1578151

PSI	4000
GPM	3.5
Max Water Temp	140°F
Power	11-13hp Gas engine
Shaft size	1" keyed
Nozzle size	#3.5

The manufacturer reserves the right to make improvements in design and/or changes in specifications at any time without incurring any obligation to install them on units previously sold.

Parts Explosion Rev. D

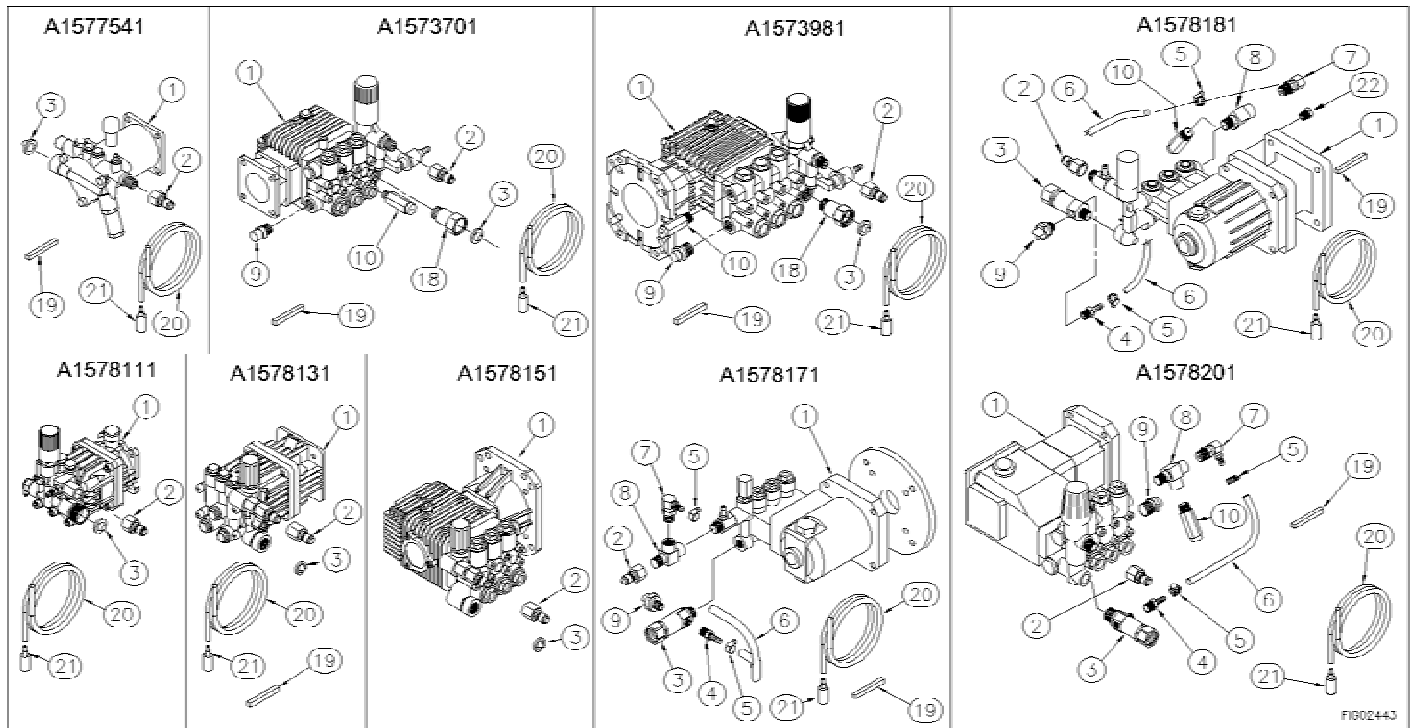

F1602443

Item	Part#	Description	Qty	Model
1	38514	Comet VRX Pump	1	A1577541
	35811	General TP 2530	1	A1573701
	35812	General EZ3040	1	A1573981
	779404	Comet BXD Pump	1	A1578111
	38518	Cat 3DX Pump	1	A1578171
	38516	Comet AXD Pump	1	A1578131
	777654	Cat 3SP Pump	1	A1578181
	38517	Comet ZWD Pump	1	A1578151
	38520	Cat 66DX Pump	1	A1578201
2	777915	Quick Connect Outlet Plug	1	all
3	4027	Inlet Filter	1	A1577541, 3701, 3981,8111,8131,8151
	38596 35169	Inlet Filter Inlet Filter	1	a1578171,818 A1578201
4	777340	1/4" x 1/4" Hose Barb Fitting	1	A1578171,8181,8201
5	777834	1/4" Hose Clamp	2	A1578171,8181,8201

Item	Part#	Description	Qty	Model
6	777165	1/4" PVC Hose	14"	A1578171,8181,8201
7	38584	Easy Start Valve	1	A1578171,8181,8201
8	777347	3/8" Street Tee	1	A1578171,8181,8201
9	35918	Thermal Valve	1	A1578171,8181
	777836	Thermal Valve	1	A1578201,3701,3981
10	22393	Pop Off Valve	1	A1578181,8201
	35814	Pop Off Valve	1	A1573701
	22392	Pop Off Valve	1	A1573981
18	35813	Manifold Inlet	1	A1573701,3981
19	82141	3/16" x 1.5" Shaft Key	1	A1578111,8171
	82142	3/16" x 2" Shaft Key	1	A1573701
	82143	1/4" x 1 3/4" Shaft key	1	A1578181,8131,3981,8151,8201
20	2212	Chemical Strainer	1	all
21	777165	1/4" Chemical Hose	3ft	all
22	777837	3/8" plug	1	A1578181